

Bollard 700

PROJECT:
TYPE:
SOURCE:
NOTES:

PURELED SPECIFICATIONS

LED Chip	Cree XHP-50-2 Plug and Play field replaceable LED board
Luminaire Output	510 Lumens @ 1050mA (6 watts), 340 Lumens @ 700mA (4 watts), 160 Lumens @ 350mA (2 watts), delivered from luminaire with unobstructed beam.
Lumens Per Watt	85 Lumens minimum @ 6 watts, delivered from luminaire with unobstructed beam
CRI (3000K)	90+
Colour Temperatures	2700K, 3000K, 4000K
Beam Angles	360 degrees
Ingress Protection	IP56/IP66
Warranty	Electronics = 5 years Body Cop/ SS = 10 years Body Aluminium = 5 years
Standards	AS/NZS 61046 cUL 1838, 2108 CSA C22.2 No.250.7, No.250.0-08 CE

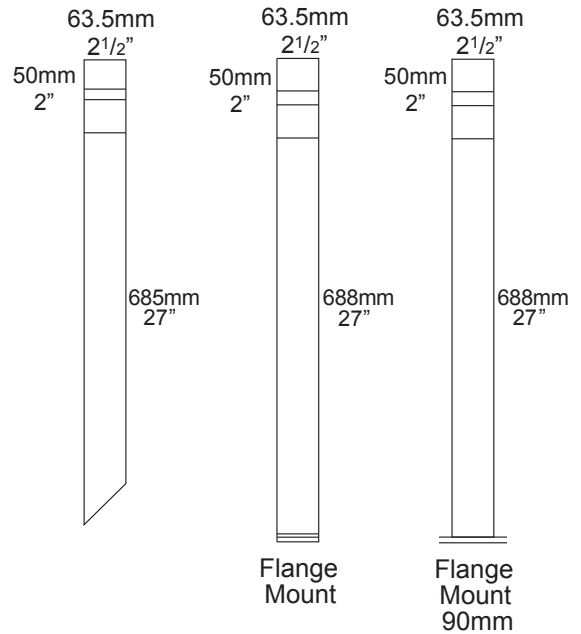

PRODUCT CONFIGURATION

Please fill in appropriate codes into boxes provided

Cat. No. BOL700/L

Luminaire	Power	Material/Finish	Beam	Colour	Accessories
<input type="text" value="BOL700/L"/>	<input type="text"/>	<input type="text"/>	<input type="text"/>	<input type="text"/>	<input type="text"/>
S SERIES, REMOTE DRIVER D3 12VAC, 2W INTEGRAL D7 12VAC, 4W INTEGRAL D10 12VAC, 6W INTEGRAL R RETRO, 110/240V DRIVER		ALUMINIUM EBK BLACK EBZ BRONZE EOGR OLIVE GREEN EWH WHITE EWB WHITE BIRCH EDG DARK GREY ESTAR SILVER STAR ECT CORTEN COP SOLID COPPER SS STAINLESS STEEL	360 360°	2 2700K 3 3000K 4 4000K	CJK CABLE JOINT KIT BOLOP OPAQUE LENS HOOD140C HOOD 140MM CONTOURED HOOD140S HOOD 140MM SMOOTH FM FLANGE MOUNT FM90 EXTERNAL FLANGE MOUNT 90

SERIES, REMOTE DRIVER REQUIRED:
Constant current driver
Individual fixtures require 6vdc @ 1050mA maximum

12VAC INTEGRAL DRIVER:
Hunza integrated plug and play driver (included)
Input: 9-15VAC.
Output: 6vdc @ D3=350mA, D7=700mA, D10=1050mA (1050mA limited to ≤ 40°C (104°F) ambient temperature in stainless steel)

110/240VAC RETRO DRIVER:
Input: 120/240vac, 5 watt total (included)
Output: 6vdc, 700mA
0-10 volt dimming (USA - non dimming)

OTHER LAMP OPTIONS:
 BOL700/H - MR16 Halogen 12V Lamp
 BOL700/SL - MR16 LED Retrofit 12V Lamp (lamps vary by market - please refer to supplier for details)
 BOL700/GUH - GU10 120/240V Halogen Lamp (body length increases for all GU10 lamps)
 BOL700/GUSL - GU10 LED Retrofit 120/240V Lamp (lamps vary by market - please refer to supplier for details)

[Click here for 240v Remote Power Supply Guidance Charts](#)
[Click here for USA Remote Power Supply Guidance Charts](#)

[Click here for halogen specification sheet](#)

LUMINAIRE CONSTRUCTION

CNC machined from one of the following metals:

Aluminium:

Body: Solid high corrosion resistant 63.5mm (2½") x 10mm (3/8") aluminium.
 Pole: 63.5mm (2½") aluminium.
 End cap: solid aluminium 63.5mm (2½") rod, with chromate substrate and high UV resistant polyester powder coat.
 Colours:
 Black, Bronze, Silver Star, White, White Birch, Olive Green, Dark Grey, Corten.

Copper:

Body: 63.5mm (2½") x 10mm (3/8").
 Pole: solid copper 63.5mm (2½").
 End cap: solid copper 63.5mm (2½") rod.

316 Stainless Steel:

Body: 63.5mm (2½") x 10mm (3/8").
 Pole: 316 stainless steel 63.5mm (2½").
 End cap: solid 316 stainless steel 63.5 (2½") rod.

Anti-glare Hood:

140mm (5½") x 1.2mm (1/16") handspun aluminium, copper or stainless steel. No upward light or glare projected.

Lens:

UV stable polycarbonate lens with anti-glare mesh and dual angle reflector projects light horizontally and at 45° onto the ground.

Gaskets:

Silicone, iron impregnated 220°C (428°F)

Mounting:

Set in concrete in the ground or specify with flange mount option, which bolts to concrete, tiling or wooden decks.

Luminaire Weight:

Low voltage
 Alum: 0.870kg (1lb 15oz)
 Cop: 2.290kg (5lb 1oz)
 SS: 2.170kg (4lb 13oz)
 Retro™
 Alum: 2.700kg (5lb 15oz)
 Cop: 5.200kg (11lb 7oz)
 SS: 4.650kg (10lb 4oz)

ACCESSORIES

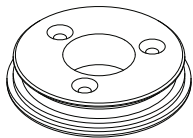

Flange Mount

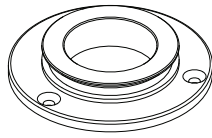

Flange Mount 90

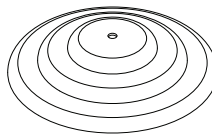

Hood 140mm Contoured

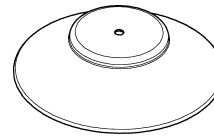

Hood 140mm Smooth

BEAM ANGLES

IES files available for download: hunzalighting.com/downloads

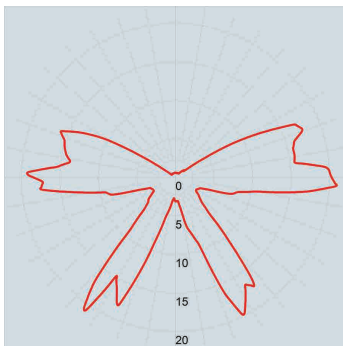

Polycarbonate lens

WIRING GUIDE

Available for download: hunzalighting.com/downloads

Series/remote driver

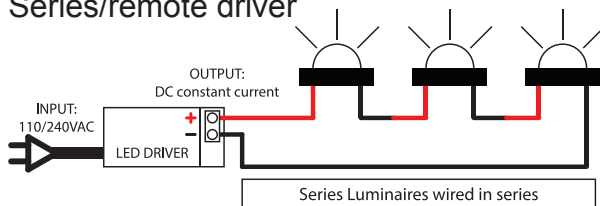

Diagrams are a guide only, wire colours and polarity may change depending on fixture and country

12v integral driver

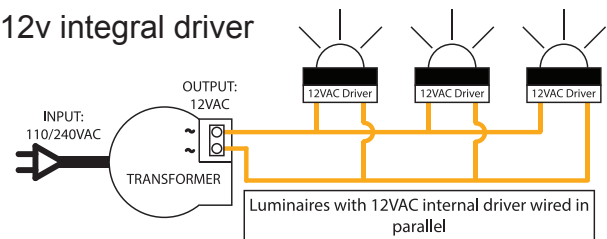

Specifications may change without notification

Aug 2017