

## Ceiling Mount ULTRA

PROJECT: \_\_\_\_\_

TYPE: \_\_\_\_\_

SOURCE: \_\_\_\_\_

NOTES: \_\_\_\_\_

### SPECIFICATIONS



<b>LED Chip</b>	Cree CXA 2540 field replaceable LED board
<b>Luminaire Output</b>	5000 Lumens @ 1400mA (52 watts) , Delivered from Luminaire with unobstructed beam.
<b>Lumens Per Watt</b>	90 Lumens minimum @ 52 watts, Delivered from Luminaire with unobstructed beam
<b>CRI (3000K)</b>	80 Standard, 90+ Optional
<b>Colour Temperatures</b>	2700K, 3000K, 4000K
<b>Beam Angles</b>	13, 22, 33, 51
<b>Ingress Protection</b>	IP66
<b>Warranty</b>	Electronics = 5 years Body Aluminium = 5 years
<b>Standards</b>	BS/EN 60598.2.2 cUL 1598 CE

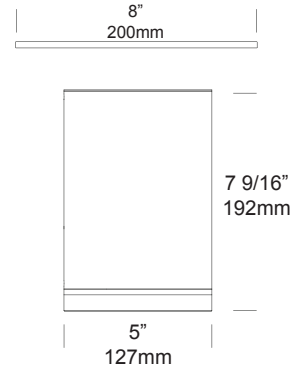

### PRODUCT CONFIGURATION

Please fill in appropriate codes into boxes provided

Cat. No. CM/U

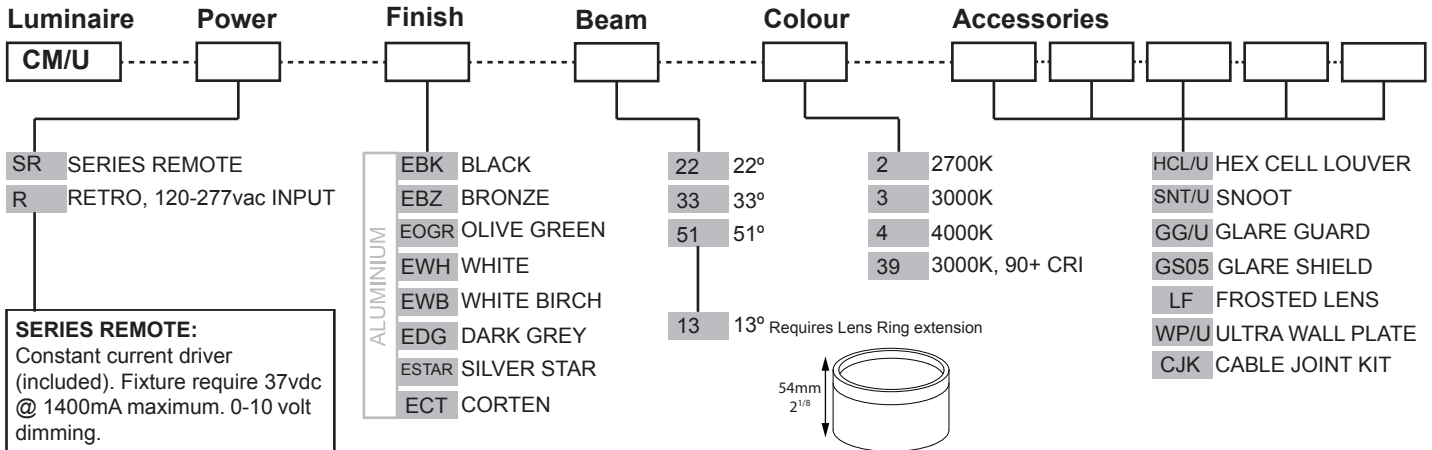

**SERIES REMOTE:**  
Constant current driver (included). Fixture require 37vdc @ 1400mA maximum. 0-10 volt dimming.

**RETRO 110-277vac DRIVER:**  
Constant current driver (included).  
Input: 120, 240, 277 volts.  
Output: 60 watts total  
37vdc @ 1400mA  
0-10 volt dimming.

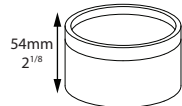

ADDITIONAL COMMENTS: \_\_\_\_\_

# LUMINAIRE CONSTRUCTION

## CNC machined from one of the following metals:

Body - solid high corrosion resistant 127mm (5") aluminium rod.  
 Base - high corrosion resistant 127mm (5") x 3.18mm (1/8") aluminium tube.  
 Finished with chromate substrate, Epoxy layer and a UV resistant polyester powder coat colour.  
 Fixings and Mechanism - made from 316 Stainless Steel

## Colours:

Black, Bronze, Silver Star, White, Birch, Olive Green, Dark Grey, Corten.

## Step Lens:

12mm (1/2") Extra clear, low iron, shatter resistant glass.  
 Lifetime warranty

## Gaskets:

Silicone, iron impregnated 220°C (428°F)

## Cable:

Water resistant rubber

## Mounting:

The mounting plate is fixed to the surface using three stainless screws. The luminaire is then fixed to the mounting plate

## Luminaire Weight:

5kg (11 lbs)

# ACCESSORIES

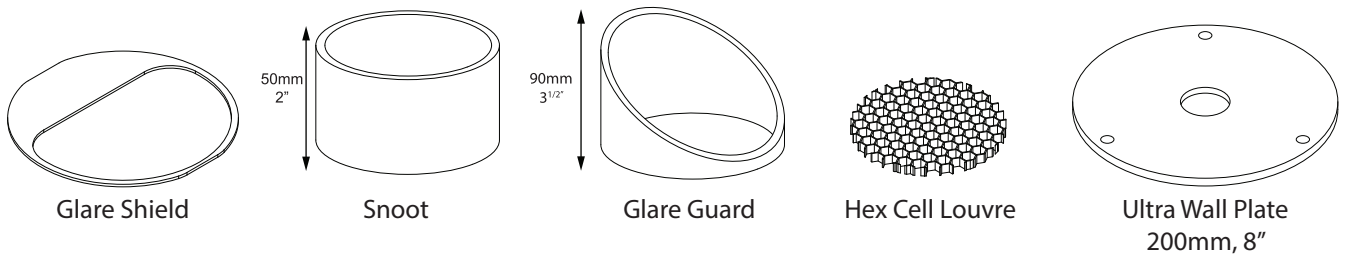

# BEAM ANGLES

High efficiency Reflectors. Feild replaceable

IES files available for download: [hunzalighting.com/downloads](http://hunzalighting.com/downloads)

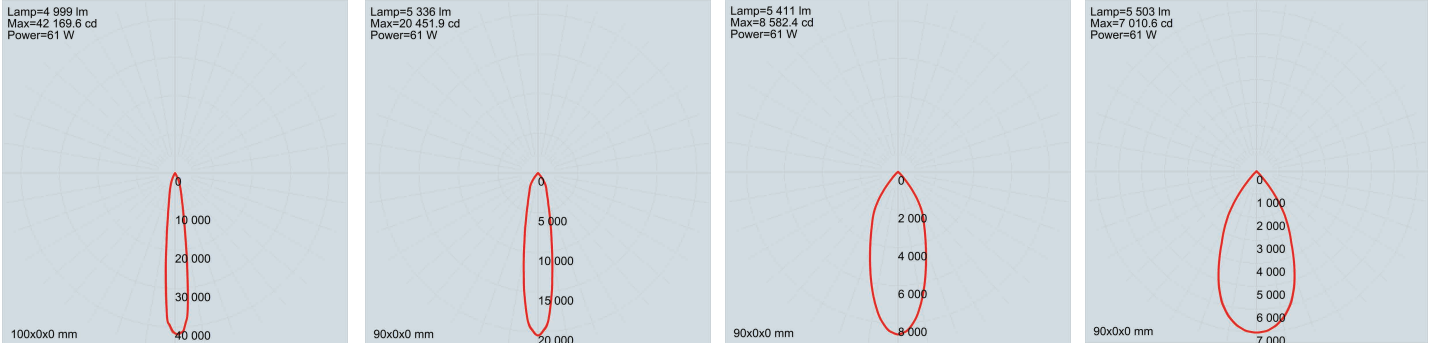

# WIRING GUIDE

Available for download: [hunzalighting.com/downloads](http://hunzalighting.com/downloads)

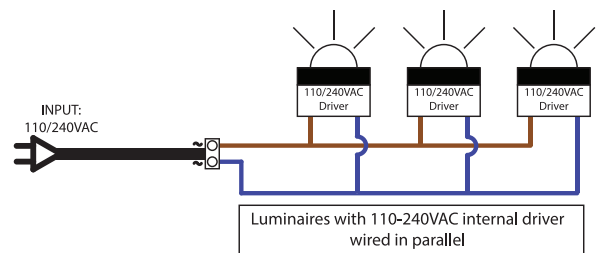
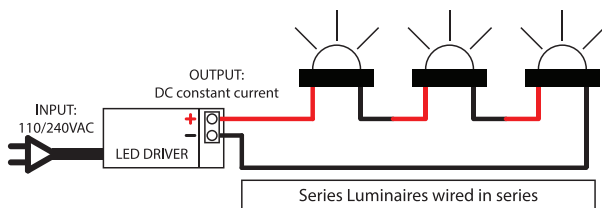

Diagrams are a guide only, wire colours and polarity may change depending on fixture and country